



Valve Regulated Lead-Acid Battery

VRLA BATTERY

Valve Regulated Lead-Acid Battery

VRLA BATTERY

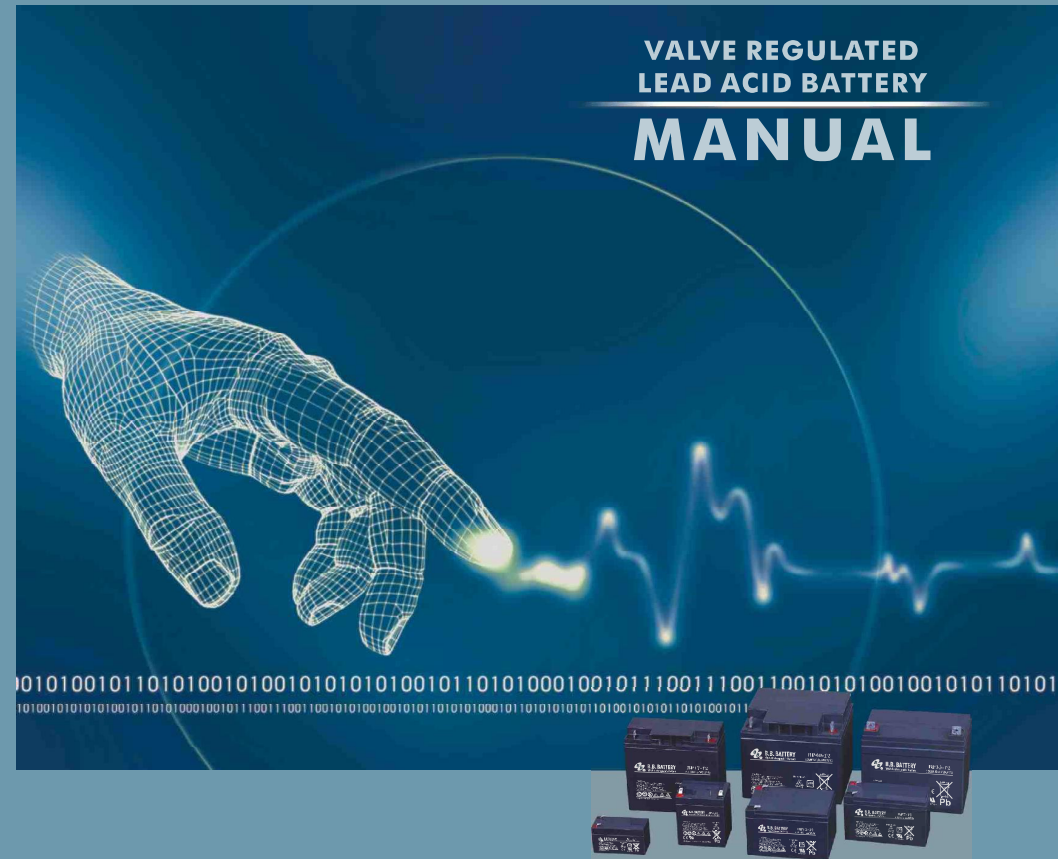

B.B. BATTERY Web Site: <http://www.bb-battery.com>



Revised in 2010.11 - 8/E

CHINA FACTORY:

B.B. BATTERY CO., LTD.
CHENG DONG TRIAL AREA, HUANG GANG, RAOPING, GUANG DONG, CHINA, 515700 TEL: 86-768-7601001-2 FAX: 86-768-7601469

USA:

B&B BATTERY (USA) INC.
6415 RANDOLPH ST. COMMERCE, CA, 90040 U.S.A. TEL: 1-323-278-1900, 1-800-278-8599 FAX: 1-323-278-1268

EUROPE:

B&B BATTERY (EUROPE) B.V.
SUITE 8, HAAKSBERGWEG 33, 1101 BP AMSTERDAM, THE NETHERLANDS TEL: 31-30-3200190 MOBILE: 896-933896989

JAPAN:

B&B BATTERY (JAPAN) CO., LTD.
1375-11 NARAHARA-MACHI, HACHIOJI, TOKYO 183-0803, JAPAN. TEL: 81-426-25-6375 FAX: 81-426-25-6375

TAIWAN:

B.B. BATTERY (TAIWAN) CO., LTD. TEL: 886-6-502-5150 FAX: 886-6-589-8087

HONG KONG:

B&B BATTERY (Hong Kong) Co. TEL: 852-2311-4918 FAX: 852-2739-1182

BEST & BEST

INTRODUCTION

The B.B. Valve-Regulated Sealed Lead-Acid Battery (VRLA BATTERY) is a new type of sealed lead-acid battery system developed by B.B. Battery Co., Ltd. It is a backup battery for portable equipment and office and factory automation. The mainly types are BP and HR series.

The B.B. VRLA battery has high power density, low self-discharge, and gives high performance while still being economical to use. In addition to these advantages, the sealed construction eliminates the necessity to fill it with water. Thus this battery is maintenance free.

This technical manual describes the basic construction, technical feature, and charge method of the B.B. VRLA battery to ensure appropriate operation. And repeated the factors which should be noted during used. Please read this manual before you use B.B. battery.

TECHNICAL FEATURES

● Sealed Construction

BB unique construction and sealing technique ensures that no electrolyte leakage should occur from the terminals or case of any BB battery. This feature provides for safe and efficient operation of BB batteries in any orientation. BB batteries are classified as "Non-Spillable" and meet all requirements of the International Air Transport Association. (I.A.T.A. Dangerous Goods Regulations).

● Electrolyte Suspension System

All BB batteries utilize an electrolyte suspension system consisting of a glass fibre separator material. This suspension system helps to achieve maximum service life, by fully retaining the electrolyte and preventing its escape from the separator material. No silica gels or other contaminants are used.

● Gas Generation

BB batteries incorporate a unique design that effectively recombines over 99% of the gas generated during normal usage.

● Maintenance Free Operation

During the life of BB batteries, there is no need to check their specific gravity or add water etc. In fact, there are no provisions for such maintenance functions to be carried out.

● Operation In Any Orientation

The combination of sealed construction and BB's electrolyte suspension system permits operation of BB batteries in any orientation but upside-down position should be avoided in operation and transportation. Battery will not lose its capacity, electrolyte, or service life under any orientation.

● Low Pressure Venting System

BB batteries are equipped with a safe, low pressure venting system, which is designed to release excess gas and reseat automatically in the event of the internal gas pressure rising to an unacceptable level. This low pressure venting system, coupled with the significantly high recombination efficiency, make BB batteries one of the safest valve regulated lead acid batteries available.

● Heavy Duty Grids

The heavy duty lead calcium alloy grids in BB batteries provide an extra margin of performance and service life in both float and cyclic applications, even in conditions of deep discharge.

TECHNICAL FEATURES

● Low Self Discharge-Long Shelf Life.

At temperatures of between 20 & 25°C, the self discharge rate of BB batteries per month is approximately 3% of their rated capacity. This low self discharge rate permits storage for up to six months without any appreciable deterioration of battery performance.

● Operating Temperature Range

BB batteries can be used over a broad range of ambient temperatures, allowing considerable flexibility in system design and location.

● High Recovery Capability

BB batteries have excellent charge acceptance and recovery capability, even after very deep discharge.

● Quality Assurance

Our CHINA manufacturing plant now has Quality Assurance Standard ISO 9001

APPLICATIONS

A list of some of the more common applications for standby or principal power is given below:

- Alarm Systems
- Cable Television
- Communications Equipment
- Computers
- Control Equipment
- Electronic Cash Registers
- Electronic Test Equipment
- Emergency Lighting Systems
- Fire & Security Systems
- Geophysical Equipment
- Marine Equipment
- Medical Equipment
- Microprocessor Based Office Machines
- Portable Cine & Video Lights
- Power Tools
- Solar Powered Systems
- Telecommunication Systems
- Television & Video Recorders
- Toys
- Uninterruptible Power Supplies
- Vending Machines

BB BATTERY CONSTRUCTION

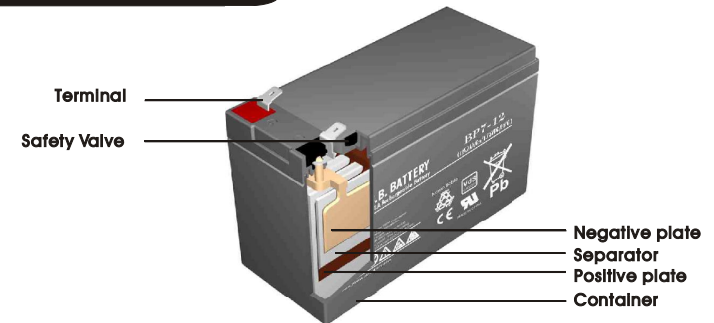

BP Series For General Use

SPECIFICATIONS

Model	Voltage (V)	Nominal Capacity (Ah)				Weight		Terminal				Dimension								MAX Discharge Current For 5 sec (A)	Ambient Temperature			MAX Charge Current (A)	
		20hr	10hr	5 hr	1 hr	kg	lbs	Standard		Optional		MM				INCH					Charge	Discharge	Storage		
								Type	Posl	Type	Posl	L	W	H	TH	L	W	H	TH						
BP10-4	4	10.0	9.50	8.50	6.00	1.31	2.98	T1	3	T2			101	50	94	100	3.98	1.97	3.70	3.94	150.0				3.00
BP10-6	6	1.0	0.95	0.85	0.60	0.25	0.55	T1	1				51	42	51	56	2.01	1.65	2.01	2.20	15.0				0.90
BP12-6	6	1.2	1.14	1.02	0.72	0.30	0.66	T1	2				97	25	51	56	3.82	0.98	2.01	2.20	18.0				0.96
BP3-6	6	3.0	2.85	2.55	1.80	0.65	1.43	T1	2	T2			134	34	60	66	5.28	1.34	2.38	2.60	45.0				0.90
BP4-6	6	4.0	3.80	3.40	2.40	0.85	1.87	T1	1	T2			70	47	101	106	2.76	1.85	3.98	4.17	60.0				1.20
BP4.5-6	6	4.5	4.28	3.83	2.70	0.91	2.01	T1	1	T2			70	48	102	107	2.76	1.89	4.02	4.21	67.5				1.35
BP5-6	6	5.0	4.75	4.25	3.00	0.95	2.09	T1	1	T2			70	48	102	107	2.76	1.89	4.02	4.21	75.0				1.50
BP7-6	6	7.0	6.65	5.95	4.20	1.26	2.78	T1	2	T2			151	34	94	100	5.94	1.34	3.70	3.94	105.0				2.10
BP8-6	6	8.0	7.60	6.80	4.80	1.35	2.98	T1	2	T2			151	34	94	100	5.94	1.34	3.70	3.94	120.0				2.40
BP8-6V	6	8.0	7.60	6.80	4.80	1.55	3.42	T1	14	T2			98	56	118	118	3.86	2.20	4.65	4.65	120.0				2.40
BP10-6	6	10.0	9.50	8.50	6.00	1.90	4.19	T1	2	T2			151	50	94	100	5.94	1.97	3.70	3.94	150.0				3.00
BP12-6	6	12.0	11.40	10.20	7.20	1.98	4.37	T1	2	T2			151	50	94	100	5.94	1.97	3.70	3.94	180.0				3.60
BP13-6S	6	13.0	12.35	11.05	6.50	2.50	5.51	T3	10				108	71	140	140	4.25	2.80	5.51	5.51	195.0				3.90
BP13-6H	6	13.0	12.35	11.05	6.50	2.50	5.51	H	11				108	71	140	140	4.25	2.80	5.51	5.51	195.0				3.90
BP33-6	6	33.0	31.35	28.05	19.80	6.00	13.23	B1	7	T2	6		181	76	166	166	7.13	2.99	6.54	6.54	495.0				9.90
BP1.2-12	12	1.2	1.14	1.02	0.72	0.59	1.30	T1	4				97	45	53	59	3.82	1.77	2.09	2.32	18.0				0.96
BP2.3-12	12	2.3	2.19	1.96	1.38	0.94	2.07	T1	2				178	34	60	65	7.01	1.34	2.36	2.56	34.5				0.89
BP3-12	12	3.0	2.85	2.55	1.80	1.30	2.87	T1	4	T2			134	67	60	66	5.28	2.64	2.38	2.60	45.0				0.90
BP3.6-12	12	3.6	3.42	3.06	2.16	1.32	2.91	T1	4	T2			134	67	60	66	5.28	2.64	2.36	2.60	54.0				1.80
BP4-12	12	4.0	3.80	3.40	2.40	1.67	3.68	T1	3	T2			90	70	102	106	3.54	2.76	4.02	4.17	60.0				1.20
BP4.5-12	12	4.5	4.28	3.83	2.70	1.84	4.06	T1	3	T2			90	70	102	106	3.54	2.76	4.02	4.17	67.0				1.35
BP5-12	12	5.0	4.75	4.25	3.00	1.80	3.97	T1	3	T2			90	70	102	106	3.54	2.76	4.02	4.17	75.0				1.50
BP7-12	12	7.0	6.65	5.95	4.20	2.54	5.60	T2	5	T1			151	65	93	98	5.94	2.56	3.68	3.86	105.0				2.10
BP7.5-12	12	7.5	7.13	6.38	4.50	2.65	5.84	T2	5	T1			151	65	94	100	5.94	2.56	3.70	3.94	112.5				2.25
BP8-12VS	12	8.0	7.60	6.80	4.80	3.10	6.84	T1	14	T2			114	98	118	118	4.49	3.86	4.65	4.65	120.0				2.40
BP8-12VL	12	8.0	7.60	6.80	4.80	3.10	6.84	T1	14	T2			198	56	118	118	7.80	2.20	4.65	4.65	120.0				2.40
BP10-12	12	10.0	9.50	8.50	6.00	3.30	7.28	T2	5	T1			151	56	112	116	5.94	2.56	4.41	4.57	150.0				3.00
BP12-12	12	12.0	11.40	10.20	7.20	3.94	8.69	T2	5	T1			151	98	94	98	5.94	3.86	3.70	3.86	180.0				3.60
BP17-12	12	17.0	16.15	14.45	10.20	6.15	13.56	B1	7	T2,11	6		181	76	166	166	7.13	2.99	6.54	6.54	255.0				5.10
BP20-12	12	20.0	19.00	17.00	12.00	6.35	14.00	B1	7	T2,11	6		181	76	166	166	7.13	2.99	6.54	6.54	300.0				6.00
BP26-12	12	26.0	24.70	22.10	15.60	9.40	20.73	B1	7	T2,11	9		175	166	125	125	6.89	6.54	4.92	4.92	390.0				7.80
BP28-12	12	28.0	26.60	23.80	16.80	9.60	21.17	B1	7	T2,11	9		175	166	125	125	6.89	6.54	4.92	4.92	420.0				8.40
BP33-12S	12	33.0	31.35	28.05	19.80	11.25	24.81	B7	8				195	129	155	179	7.68	5.08	6.10	7.05	495.0				9.90
BP33-12H	12	33.0	31.35	28.05	19.80	11.25	24.81	B7	8	I2			210	129	168	179	8.27	5.08	6.61	7.05	495.0				9.90
BP33-12F	12	33.0	31.35	28.05	19.80	11.25	24.81	B7	8	I2			210	129	168	179	8.27	5.08	6.61	7.05	495.0				9.90
BP35-12S	12	35.0	33.25	29.75	21.00	11.45	25.25	B7	8				195	129	155	179	7.68	5.08	6.10	7.05	525.0				10.50
BP35-12H	12	35.0	33.25	29.75	21.00	11.45	25.25	B7	8	I2			210	129	168	179	8.27	5.08	6.61	7.05	525.0				10.50
BP35-12F	12	35.0	33.25	29.75	21.00	11.45	25.25	B7	8	I2			210	129	168	179	8.27	5.08	6.61	7.05	525.0				10.50
BP40-12	12	40.0	38.00	34.00	24.00	14.30	31.53	B2	7	I1,12			197	165	171	171	7.76	6.50	6.73	6.73	600.0				12.00
BP65-12	12	65.0	61.75	55.25	39.00	22.40	49.38	B5	15	I2			350	166	174	174	13.78	6.54	6.85	6.85	650.0				19.50
BP90-12	12	90.0	86.50	76.50	54.00	30.80	67.90	B3	15	I2			329	172	215	238(B3) 220(I2)	12.95	6.77	8.46	9.37(B3) 8.61(I2)	900.0				27.00
BP100-12	12	100.0	95.00	85.00	60.00	32.70	72.10	B3	15	I2			329	172	215	238(B3) 220(I2)	12.95	6.77	8.46	9.37(B3) 8.61(I2)	1000.0				30.00
BP120-12	12	120.0	114.0	102.0	72.00	39.50	87.10	B4	18	I2			407	173	210	239	16.02	6.81	8.27	9.41	1200.0				36.00
BP160-12	12	160.0	152.0	136.0	96.00	51.20	112.9	B9	8	I3			483	171	240	240	19.02	6.73	9.45	9.45	1600.0				48.00
BP200-12	12	200.0	190.0	170.0	120.0	61.50	135.6	B9	13	I3			522	204	216	240(B9) 219(I3)	20.55	7.95	8.50	9.45(B9) 8.61(I3)	2000.0				60.00
BP230-12	12	230.0	218.0	195.0	138.0	72.50	159.8	B9	13	I3			522	240	216	240(B9) 219(I3)	20.55	9.45	8.50	9.45(B9) 8.61(I3)	2300.0				69.00

*Remark : (1) BP33-12 S Standard Type (2) BP33-12 H Handle Type (3) BP33-12 F Finger Type

All data subject to change without notice

TERMINAL POSITION



3

4

HR Series For High Rate Use

SPECIFICATIONS

Model	Voltage (V)	Nominal Capacity (Ah)		Weight		Terminal				Dimension								MAX Discharge Current For 5 sec (A)	Ambient Temperature			MAX Charge Current (A)
		15Min Rate W/Cell	10hr Rate Ah	kg	lbs	Standard		Optional		MM				INCH					Charge	Discharge	Storage	
						Type	Posl	Type	Posl	L	W	H	TH	L	W	H	TH					
HR9-6	6	36.0	8.0	1.40	3.09	T2	2	T1		151	34	94	100	5.94	1.34	3.70	3.94	120	0°C (32°F) 40°C (104°F)	-20°C (-4°F) 50°C (122°F)	-20°C (-4°F) 40°C (104°F)	2.40
HR4-12	12	16.0	3.5	1.40	3.09	T1	4	T2		134	67	60	66	5.28	2.64	2.36	2.60	52.5				1.05
HR5.5-12	12	22.0	5.0	1.80	3.97	T1	3	T2		90	70	102	106	3.54	2.76	4.02	4.17	75				1.50
HR5.8-12	12	23.0	5.3	1.88	4.15	T1	3	T2		90	70	102	106	3.54	2.76	4.02	4.17	79.5				1.59
HR6-12	12	24.0	5.5	2.10	4.63	T1	5	T2		151	51	94	100	5.94	2.01	3.70	3.94	82.5				1.65
HR8-12	12	32.0	7.0	2.60	5.73	T2	5	T1		151	65	94	100	5.94	2.56	3.70	3.94	105				2.10
HR9-12	12	36.0	8.0	2.75	6.06	T2	5	T1, B0		151	65	94	100	5.94	2.56	3.70	3.94	120				2.40
HR15-12	12	60.0	13.0	4.20	9.26	T2	5	T1		151	98	94	98	5.94	3.86	3.70	3.86	180				3.90
HR22-12	12	88.0	20.0	6.50	14.33	B1	7	T2, I1	6	181	76	166	166	7.13	2.99	6.54	6.54	300				6.00
HR33-12	12	132.0	31.0	10.00	22.05	B1	7	T2, I1	9	175	166	125	125	6.89	6.54	4.92	4.92	390				9.30
HR40-12	12	160.0	38.0	12.10	26.68	B7	8	I2		210	129	168	179	8.27	5.08	6.61	7.05	495				11.40
HR50-12	12	200.0	48.0	15.30	33.74	B2	7	I1, I2		197	165	171	171	7.76	6.50	6.73	6.73	600				14.40
HR75-12	12	300.0	73.0	24.75	54.57	B5	15	I2		350	166	174	174	13.78	6.54	6.85	6.85	650.0	21.90			

RT Series For Recess Terminal Use

SPECIFICATIONS

Model	Voltage (V)	Nominal Capacity (Ah)				Weight		Terminal				Dimension								MAX Discharge Current For 5 sec (A)	Ambient Temperature			MAX Charge Current (A)	
		20hr	10hr	5 hr	1 hr	kg	lbs	Standard		Optional		MM				INCH					Charge	Discharge	Storage		
								Type	Posl	Type	Posl	L	W	H	TH	L	W	H	TH						
BP4.5-12RT	12	4.5	4.28	3.83	2.70	1.78	3.92	RT	12			16	140	48	102	104	5.51	1.89	4.02	4.09	67.5	0°C (32°F) 40°C (104°F)	-20°C (-4°F) 50°C (122°F)	-20°C (-4°F) 40°C (104°F)	1.35
BP5.5-12RT	12	5.5	5.23	4.68	3.30	1.85	4.08	RT	12			16	140	48	102	104	5.51	1.89	4.02	4.09	82.5				1.65
BP7-12RT	12	7.0	6.65	5.95	4.20	2.40	5.29	RT	12			16	140	48	126	128	5.51	1.89	4.96	5.04	105.0				2.10

TERMINAL TYPE mm (inch)

• Terminal RT

• Terminal T1

• Terminal T2

• Terminal T3

• Terminal C

• Terminal H

• Terminal I1

• Terminal I2

• Terminal I3

• Terminal B0

• Terminal B1

• Terminal B2

• Terminal B3

• Terminal B4

• Terminal B5

• Terminal B6

• Terminal B7

• Terminal B9

• Terminal L1

Terminal	Maximum Permissible Current (Amps)		
	Continuous	1hr	1min
Faston tab 187	16	24	48
Faston tab 250	25	38	75
Wire Lead 0.5mm ²	7	20	30

BPL Series For Long Life Standby Use

SPECIFICATIONS

Model	Voltage (V)	Nominal Capacity (Ah)			Weight		Terminal				Dimension								MAX Discharge Current For 5 sec (A)	Ambient Temperature			MAX Charge Current (A)
		20hr Rate	5hr Rate	30Min Rate	kg	lbs	Standard		Optional		MM				INCH					Charge	Discharge	Storage	
							Type	Posl	Type	Posl	L	W	H	TH	L	W	H	TH					
BPL3.3-12	12	3.3	2.81	1.65	1.35	2.98	T1	4	T2		134	67	80	66	5.28	2.64	2.36	2.60	49.5				0.99
BPL7-12	12	7.0	5.95	3.50	2.60	5.73	T2	5	T1		151	65	93	98	5.94	2.56	3.66	3.86	105				2.10
BPL7.5-12	12	7.5	6.38	3.75	2.70	5.95	T2	5	T1		151	65	94	100	5.94	2.56	3.70	3.94	112.5				2.25
BPL12-12	12	12.0	10.20	6.00	4.10	9.04	T2	5	T1		151	98	94	98	5.94	3.86	3.70	3.86	180				3.60
BPL17-12	12	17.0	14.45	8.50	6.15	13.56	B1	7	T2.11	6	181	76	166	166	7.13	2.99	6.54	6.54	255				5.10
BPL20-12	12	20.0	17.00	10.00	6.45	14.22	B1	7	T2.11	6	181	76	166	166	7.13	2.99	6.54	6.54	300				6.00
BPL26-12	12	26.0	22.10	13.00	9.60	21.17	B1	7	T2.11	9	175	166	125	125	6.89	6.54	4.92	4.92	390				7.80
BPL28-12	12	28.0	23.80	14.00	9.70	21.39	B1	7	T2.11	9	175	166	125	125	6.89	6.54	4.92	4.92	420				8.40
BPL33-12	12	33.0	28.05	16.50	11.50	25.36	B7	8	I2		210	129	168	179	8.27	5.08	6.61	7.05	495				9.90
BPL40-12	12	40.0	34.00	20.00	14.60	32.19	B2	7	I1.I2		197	165	171	171	7.76	6.50	6.73	6.73	600				12.00
BPL65-12	12	65.0	55.25	32.50	22.70	50.05	B5	15	I2		350	166	174	174	13.78	6.54	6.85	6.85	650				19.50
BPL85-12	12	85.0	72.25	42.50	34.00	74.97	B3	15	I2		329	172	215	238(B3) 224(I2)	12.95	6.77	8.46	9.37(B3) 8.88(I2)	850				25.50
BPL95-12	12	95.0	80.75	47.50	33.20	73.20	B3	15	I2		329	172	215	238(B3) 220(I2)	12.95	6.77	8.46	9.37(B3) 8.88(I2)	950				28.50
BPL110-12	12	110.0	93.50	55.00	40.00	88.20	B4	18	I2		407	173	210	239	16.02	6.81	8.27	9.41	1100				33.00
BPL150-12	12	150.0	127.5	75.0	51.80	114.2	B9	8	I3		483	171	240	240	19.02	6.73	9.45	9.45	1500				45.00
BPL210-12	12	210.0	178.5	105.0	73.20	161.4	B9	13	I3		522	240	216	240(B9) 219.8(I3)	20.53	9.45	8.50	8.84(I3)	2100				63.00

MPL Series For High Rate, Long Life Standby Use

SPECIFICATIONS

Model	Voltage (V)	Nominal Capacity (Ah)		Weight		Terminal				Dimension								MAX Discharge Current For 5 sec (A)	Ambient Temperature			MAX Charge Current (A)
		15Min Rate W/Cell	10hr Rate Ah	kg	lbs	Standard		Optional		MM				INCH					Charge	Discharge	Storage	
						Type	Posl	Type	Posl	L	W	H	TH	L	W	H	TH					
MPL55-12(S/H)	12	220.0	53.0	17.8	39.25	B5	8	I2		228	139	200	224(B5) 207(I2)	8.98	5.47	7.87	8.82(B5) 8.15(I2)	550				15.90
MPL80-12(S/H)	12	320.0	78.0	26.0	57.33	B5	8	I2		261	173	200	224(B5) 207(I2)	10.28	6.81	7.87	8.82(B5) 8.15(I2)	800				23.40
MPL90-12(S/H)	12	360.0	88.0	29.8	65.71	B3	8	I2		306	173	200	230(B3) 207(I2)	12.05	6.81	7.87	9.06(B3) 8.15(I2)	900				26.40
MPL110-12(S/H)	12	440.0	108.0	34.3	75.62	B3	8	I2		330	173	212	241(B3) 218(I2)	12.99	6.81	8.38	9.48(B3) 8.56(I2)	1100				32.40

*Remark : (1) (S) for Standard Type (2) (H) for Handle Type

EB Series Specially For Electrical Vehicle Use

SPECIFICATIONS

Model	Voltage (V)	Nominal Capacity (Ah)		Weight		Terminal				Dimension								MAX Discharge Current For 5 sec (A)	Ambient Temperature			MAX Charge Current (A)
		2hr Rate Ah	20hr Rate Ah	kg	lbs	Standard		Optional		MM				INCH					Charge	Discharge	Storage	
						Type	Posl	Type	Posl	L	W	H	TH	L	W	H	TH					
EB12-12	12	10.0	12.0	4.3	9.48	T2	5			151	98	94	94	5.94	3.86	3.70	3.86	180				3.6
EB20-12	12	15.0	20.0	6.45	14.22	B1	7			181	76	166	166	7.13	2.99	6.54	6.54	300				6.0
EB50-12	12	40.0	50.0	16.5	36.48	I2	7			197	165	171	171	7.76	6.50	6.73	6.73	750				15.0

EP Series For High Cycle Use

SPECIFICATIONS

Model	Voltage (V)	Nominal Capacity (Ah)			Weight		Terminal				Dimension								MAX Discharge Current For 5 sec (A)	Ambient Temperature			MAX Charge Current (A)
		20hr Rate	5hr Rate	30Min Rate	kg	lbs	Standard		Optional		MM				INCH					Charge	Discharge	Storage	
							Type	Post	Type	Post	L	W	H	TH	L	W	H	TH					
EP7-12	12	7.0	5.95	3.5	2.60	5.73	T2	5	T1		151	65	93	98	5.94	2.56	3.66	3.86	105	0°C (32°F) ↓ 40°C (104°F)	-20°C (-4°F) ↓ 50°C (122°F)	-20°C (-4°F) ↓ 40°C (104°F)	2.10
EP12-12	12	12.0	10.20	6.0	4.20	9.26	T2	5	T1		151	98	94	98	5.94	3.86	3.70	3.86	180				3.60
EP17-12	12	17.0	14.45	8.5	6.20	13.67	B1	7	T2,11	6	181	76	166	166	7.13	2.99	6.54	6.54	255				5.10
EP26-12	12	26.0	22.10	13.0	9.60	21.17	B1	7	T2,11	9	175	166	125	125	6.89	6.54	4.92	4.92	390				7.80
EP28-12	12	28.0	23.80	14.0	9.70	21.39	B1	7	T2,11		175	166	125	125	6.89	6.54	4.92	4.92	420				8.40
EP33-12	12	33.0	28.05	16.5	11.50	25.36	B7	8	I2		210	129	168	179	8.27	5.08	6.61	7.05	495				9.90
EP40-12	12	40.0	34.00	20.0	14.60	32.19	B2	7	I1,I2		197	165	171	171	7.76	6.50	6.73	6.73	600				12.00
EP65-12	12	65.0	55.25	32.5	22.80	50.30	B5	15	I2		350	166	174	174	13.78	6.54	6.85	6.85	650				19.50
EP80-12	12	80.0	68.00	40.0	34.00	74.97	B3	8	I2		329	172	215	238(B3) 220(I2)	12.95	6.77	8.46	9.37(B3) 8.68(I2)	800				24.00
EP100-12	12	100.0	85.00	50.0	40.00	88.20	B4	18	I2		407	173	210	239	16.02	6.81	8.27	9.41	1000				30.00

EVP Series For High Power, High Cycle Use

SPECIFICATIONS

Model	Voltage (V)	Nominal Capacity (Ah)			Weight		Terminal				Dimension								MAX Discharge Current For 5 sec (A)	Ambient Temperature			MAX Charge Current (A)
		20hr Rate	5hr Rate	30Min Rate	kg	lbs	Standard		Optional		MM				INCH					Charge	Discharge	Storage	
							Type	Post	Type	Post	L	W	H	TH	L	W	H	TH					
EVP7-12	12	7.0	5.95	4.4	2.75	6.06	T2	5	T1		151	65	94	100	5.94	2.56	3.70	3.94	105	0°C (32°F) ↓ 40°C (104°F)	-20°C (-4°F) ↓ 50°C (122°F)	-20°C (-4°F) ↓ 40°C (104°F)	2.10
EVP12-12	12	12.0	10.20	7.5	4.20	9.26	T2	5	T1		151	98	94	98	5.94	3.86	3.70	3.86	180				3.60
EVP20-12	12	20.0	17.00	12.5	6.60	14.55	B1	7	T2,11	6	181	76	166	166	7.13	2.99	6.54	6.54	300				6.00
EVP26-12	12	26.0	22.10	16.3	10.00	22.05	B1	7	T2,11	9	175	166	125	125	6.89	6.54	4.92	4.92	390				7.80
EVP35-12	12	35.0	29.75	21.9	12.50	27.56	B7	8	I2		210	129	168	179	8.27	5.08	6.61	7.05	525				10.50
EVP44-12	12	44.0	37.40	27.5	15.50	34.18	B2	7	I1/I2		197	165	171	171	7.76	6.50	6.73	6.73	600				13.20
EVP70-12	12	70.0	59.50	43.8	25.00	55.13	B5	15	I2		350	166	174	174	13.78	6.54	6.85	6.85	650				21.00

Figure 1. DISCHARGE TIME AS FUNCTION OF DISCHARGE CURRENT

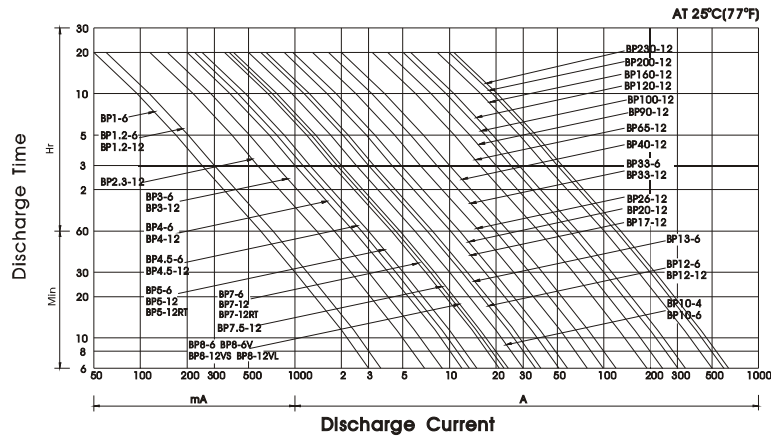

Figure 1

BATTERY CAPACITY SELECTION

Figures 1 and 2 may be used to determine the minimum battery size, expressed in Ampere hours of capacity. To determine the required minimum battery capacity, plot the required discharge current, on the horizontal axis, against time. The point where the current and time lines intersect on or below the diagonal Ah curve shows the minimum capacity required for the application. In practice, if the intersection point of the time & current does not fall exactly on a particular Ah curve, the next higher value Ah curve should be used to determine the minimum battery capacity/size.

Figure 2. CAPACITY SELECTION CHART

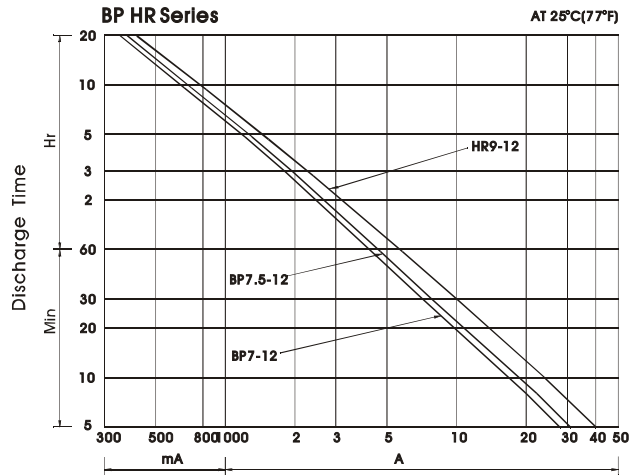

Figure 2

DISCHARGE

Discharge Characteristics

The curves shown in Figure 2 and Figure 3 and the discharge rates shown in Table 1 and Table 3 illustrate the typical discharge characteristics of BB BP batteries at an ambient temperature of 25°C. The symbol "C" expresses the nominal capacity of the battery measured at a 20-Hour discharge rate. Please refer to General Specifications on page 3 to determine the nominal capacity rating of specific BP models. The standard industry practice to determine the nominal capacity of a valve regulated lead acid battery is to discharge the battery under test at its 20-Hour rate to a final voltage of 1.75 volts per cell.

The curves in Figure 3 show the different currents that can be drawn at various discharge capacity rates at an ambient temperature of 25°C. Table 1 and Table 3 show that the rated nominal capacity of a battery is reduced when it is discharged at a value of current that exceeds its 20-Hour discharge rate. This should be taken into consideration when a battery is being selected for a particular application.

Figure 3. BP BATTERY DISCHARGE CHARACTERISTICS (25°C/77°F)

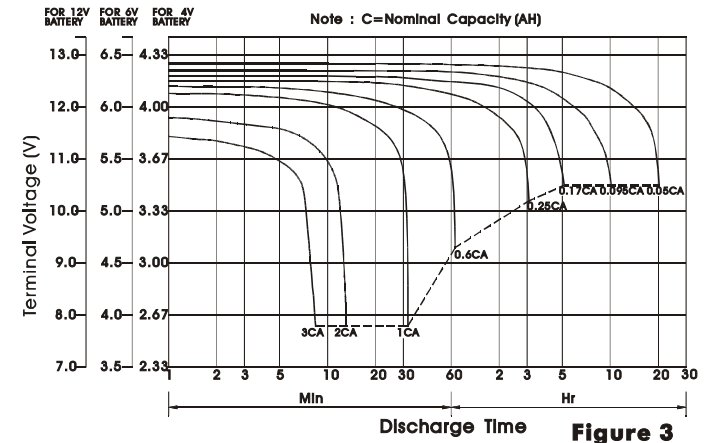

Figure 3

Figure 4. HR SERIES BATTERY DISCHARGE CHARACTERISTICS (25°C/77°F)

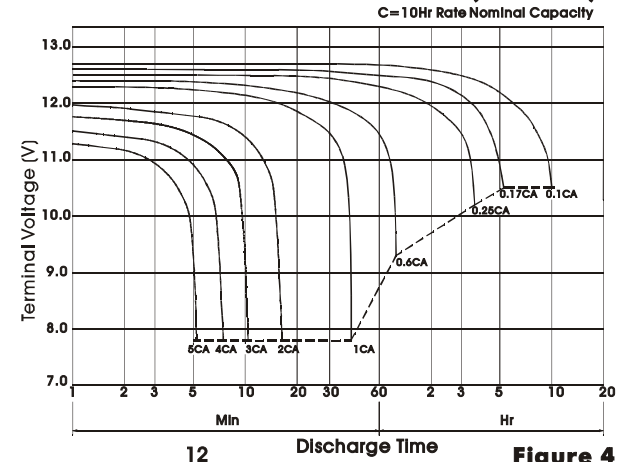

Figure 4

DISCHARGE

Table1.DISCHARGE CURRENT AT STIPULATED DISCHARGE RATES

Nominal capacity (20 hr rate)	Discharge Current (A)								
	0.05C	0.095C	0.17C	0.25C	0.6C	1C	2C	3C	
1.0Ah	0.05	0.095	0.17	0.25	0.6	1.0	2.0	3.0	
1.2Ah	0.06	0.114	0.204	0.3	0.72	1.2	2.4	3.6	
2.3Ah	0.115	0.219	0.391	0.575	1.38	2.3	4.6	6.9	
3Ah	0.15	0.285	0.51	0.75	1.8	3.0	6.0	9.0	
3.6Ah	0.18	0.342	0.60	0.90	2.16	3.60	7.20	10.8	
4Ah	0.2	0.38	0.68	1.0	2.4	4.0	8.0	12.0	
4.5Ah	0.225	0.428	0.765	1.125	2.7	4.5	9.0	13.5	
5Ah	0.25	0.475	0.85	1.25	3.0	5.0	10.0	15.0	
7Ah	0.35	0.665	1.19	1.75	4.2	7.0	14.0	21.0	
7.5Ah	0.375	0.713	1.275	1.875	4.5	7.5	15.0	22.5	
8Ah	0.4	0.76	1.36	2.0	4.8	8.0	16.0	24.0	
10Ah	0.5	0.95	1.7	2.5	6.0	10.0	20.0	30.0	
12Ah	0.6	1.14	2.04	3.0	7.2	12.0	24.0	36.0	
13Ah	0.65	1.235	2.21	3.25	7.8	13.0	26.0	39.0	
17Ah	0.85	1.615	2.89	4.25	10.2	17.0	34.0	51.0	
20Ah	1.0	1.90	3.40	5.0	12.0	20.0	40.0	60.0	
26Ah	1.3	2.47	4.42	6.5	15.6	26.0	52.0	78.0	
28Ah	1.40	2.66	4.76	7.0	16.8	28.0	56.0	84.0	
33Ah	1.65	3.135	5.61	8.25	19.8	33.0	66.0	99.0	
35Ah	1.75	3.325	5.95	8.75	21.0	35.0	70.0	105.0	
40Ah	2.0	3.8	6.8	10.0	24.0	40.0	80.0	120.0	
65Ah	3.25	6.175	11.05	16.25	39.0	65.0	130.0	195.0	
90Ah	4.5	8.55	15.3	22.5	54.0	90.0	180.0	270.0	
100Ah	5.0	9.50	17.0	25.0	60.0	100.0	200.0	300.0	
120Ah	6.0	11.4	20.4	30.0	72.0	120.0	240.0	360.0	
160Ah	8.0	15.20	27.2	40.0	96.0	160	320	480	
200Ah	10.0	19.00	34.0	50.0	120	200	400	600	
230Ah	11.5	21.85	39.1	57.5	138	230	460	690	

Table2:

1.BP BATTERY - Watts/Ah/Cell

Final Voltage (V/Cell)	Discharge time								
	5Min	10Min	15Min	30Min	1Hr	3Hr	5Hr	10Hr	20Hr
1.80	6.026	4.436	3.555	2.114	1.2131	0.4857	0.3350	0.1871	0.098
1.75	6.974	4.805	3.719	2.195	1.2493	0.4955	0.3400	0.1900	0.100
1.70	7.410	4.979	3.833	2.245	1.2719	0.5000	0.3419	0.1910	0.1005
1.65	7.743	5.098	3.921	2.276	1.2871	0.5036	0.3431	0.1914	0.1007
1.60	8.000	5.200	4.000	2.300	1.300	0.5064	0.3440	0.1914	0.1007

Table2-1

2.Ex : BP7-12 BATTERY Watts = Watts/Ah/Cell * 7Ah * 6Cell

Final Voltage (V/Cell)	Discharge time								
	5Min	10Min	15Min	30Min	1Hr	3Hr	5Hr	10Hr	20Hr
1.80	253.1	186.3	149.3	88.8	50.95	20.40	14.07	7.86	4.11
1.75	292.9	201.8	156.2	92.2	52.47	20.81	14.28	7.98	4.20
1.70	311.2	209.1	161.0	94.3	53.42	21.00	14.36	8.02	4.22
1.65	325.2	214.1	164.7	95.6	54.06	21.15	14.41	8.04	4.23
1.60	336.0	218.4	168.0	96.6	54.60	21.27	14.45	8.04	4.23

When calculating Battery requirements for Constant Power applications use table 2

Table2-2

DISCHARGE

BP BATTERY DISCHARGE CAPACITY AT VARIOUS DISCHARGE RATES

Nominal capacity (20 hr rate)	Discharge Capacity (Ah)				
	20Hr Rate	10Hr Rate	5Hr Rate	3Hr Rate	1Hr Rate
	0.05CA to 1.75V/cell	0.095CA to 1.75V/cell	0.17CA to 1.75V/cell	0.25CA to 1.7V/cell	0.6CA to 1.55V/cell
1.0Ah	1.0	0.95	0.85	0.75	0.60
1.2Ah	1.2	1.14	1.02	0.90	0.72
2.3Ah	2.3	2.19	1.96	1.73	1.38
3.0Ah	3.0	2.85	2.55	2.25	1.80
3.6Ah	3.6	3.42	3.06	2.70	2.16
4.0Ah	4.0	3.80	3.40	3.00	2.40
4.5Ah	4.5	4.28	3.83	3.38	2.70
5.0Ah	5.0	4.75	4.25	3.75	3.00
7.0Ah	7.0	6.65	5.95	5.25	4.20
7.5Ah	7.5	7.13	6.38	5.63	4.50
8.0Ah	8.0	7.60	6.80	6.00	4.80
10Ah	10.0	9.50	8.50	7.50	6.00
12Ah	12.0	11.40	10.20	9.00	7.20
13Ah	13.0	12.35	11.05	9.75	7.80
17Ah	17.0	16.15	14.45	12.75	10.2
20Ah	20.0	19.00	17.00	15.00	12.0
26Ah	26.0	24.70	22.10	19.51	15.6
28Ah	28.0	26.60	23.80	21.00	16.8
33Ah	33.0	31.35	28.05	24.75	19.8
35Ah	35.0	33.25	29.75	26.25	21.0
40Ah	40.0	38.00	34.00	30.00	24.0
65Ah	65.0	61.75	55.25	48.75	39.0
90Ah	90.0	85.50	76.50	67.50	54.0
100Ah	100.0	95.00	85.00	75.00	60.0
120Ah	120.0	114.00	102.0	90.00	72.0
160Ah	160.0	152.00	136.0	120.0	96.0
200Ah	200.0	190.00	170.0	150.0	120.0
230Ah	230.00	218.50	195.5	172.5	138.0

Table3

Table 3. DISCHARGE CAPACITY AT VARIOUS DISCHARGE RATES

■ Over Discharge (Deep Discharge)

The dotted line in Figure 3 indicates the lowest recommended voltage under load, or cut off voltage, for BP batteries at various discharge rates. In general, lead acid batteries are damaged in terms of capacity and service life if discharged below the recommended cut off voltages. It is generally recognized that all lead calcium alloy grid batteries are subject to over discharge damage. For example, if a lead acid battery were discharged to zero volts, and left standing in either " on " or " off " load conditions for a long period of time, severe sulphation would occur, raising the internal resistance of the battery abnormally high. In such an extreme case, the battery may not accept charge. BP batteries have been designed to withstand some levels of over-discharge. However, whilst this is not the recommended way of operation, BP batteries can recover their capacity when recharged correctly. Final discharge voltage is shown in Table 4.

DISCHARGE

Table4
BATTERY DISCHARGE CURRENT AND FINAL DISCHARGE VOLTAGE

Discharge current (A)	Final discharge voltage (V/cell)
0.2C > (A) or Intermittent discharge	1.75
0.2C ≤ (A) < 0.5C	1.70
0.5C ≤ (A) < 1.0C	1.55
1.0C ≤ (A)	1.30

TABLE 4. FINAL DISCHARGE VOLTAGE
If a battery is to be discharged at a rate in excess of 5C Amps, please consult us prior to use.

Table4

TEMPERATURE CHARACTERISTICS

Figure 5 shows the effects of different temperatures in relation to battery capacity.

Figure5. TEMPERATURE EFFECTS IN RELATION TO BATTERY CAPACITY

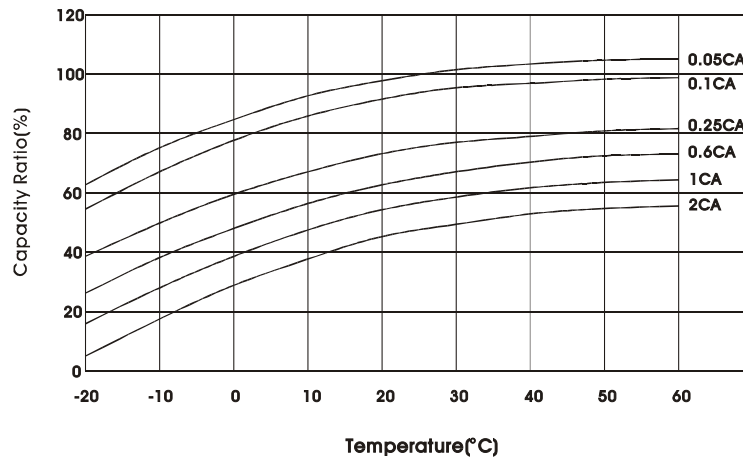

Figure5

DISCHARGE

STORAGE, SELF DISCHARGE and SHELF LIFE

Self Discharge

The self discharge rate of BP batteries is approximately 3% per month when stored at an ambient temperature of 20 °C. The self discharge rate will vary as a function of ambient storage temperature. Figure 6 shows the relationship between storage times at various temperatures and the remaining capacity.

Figure6. BATTERY SELF DISCHARGE CHARACTERISTICS

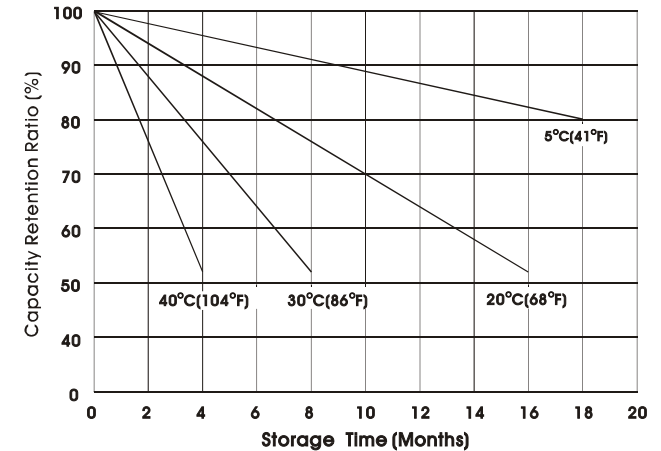

Figure6

Shelf Life

In general, when lead acid batteries of any type are stored for extended periods of time, lead sulphate is formed on the negative plates of the batteries. This phenomenon is referred to as "sulphation". Since the lead sulphate acts as an insulator, it has a direct detrimental effect on charge acceptance. The more advanced the sulphation, the lower the charge acceptance. Table 5 below shows the normal storage time or shelf life at various ambient temperatures.

Brief excursions i.e., a few days, at temperatures higher than the ranges recommended above will have no adverse effect on storage time or service life. However, should the higher ambient temperature persist for one month or more, the storage time must be determined by referring to the new ambient temperature. Ideally BP batteries should be stored in dry, cool conditions.

Table 5. Shelf Life at Various Temperatures

Temperature	Life
Below 20°C (68°F)	9 months
21°C (70°F) to 30°C (86°F)	6 months
31°C (88°F) to 40°C (104°F)	3 months
41°C (106°F) to 50°C (122°F)	1.5 months

Table5

Recharging Stored Batteries

In general, to optimize performance and service life, it is recommended that BP batteries which are to be stored for extended periods of time be given a supplementary charge, commonly referred to as a "top charge", periodically. Please refer to the recommendations listed on page 25 under Top Charging.

AVAILABLE CAPACITY, MEASURED BY OPEN CIRCUIT VOLTAGE

The approximate depth of discharge, or remaining capacity, in a BB BP battery can be empirically determined by referring to Figure 25.

IMPEDANCE

The internal resistance (Impedance) of a battery is lowest when the battery is in a fully charged state. The internal resistance increases gradually during discharge, Figure 8 shows the internal resistance of an BP7-12 battery measured through a 1,000 Hz AC bridge.

Figure7.INTERNAL RESISTANCE OF BP BATTERY

Battery : BP7-12
Ambient Temperature:25°C/77°F
Measured With 1000Hz AC Bridge

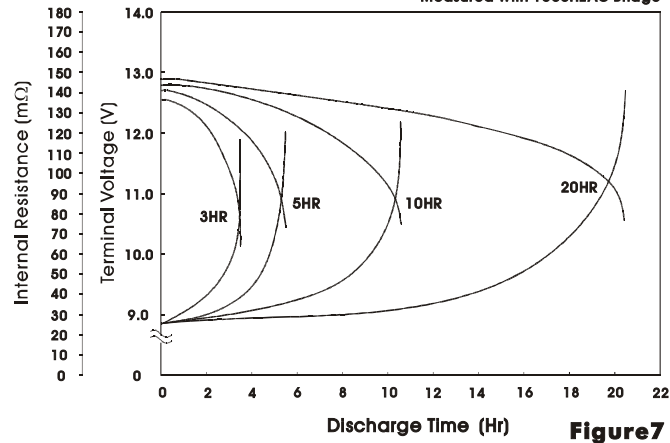

Figure7

CHARGING

Correct charging is one of the most important factors to consider when using valve regulated lead acid batteries. Battery performance and service life will be directly affected by the efficiency of the charger selected. The basic charging methods are:

- Constant Voltage Charging
- Constant Current Charging
- Taper Current Charging
- Two Stage Constant Voltage Charging

CHARGING

Constant Voltage Charging

Charging at constant voltage is the most suitable and commonly used method for charging valve regulated lead acid batteries. Figure8 and Figure9, Figure10 show the charging characteristics of BP battery when charged by constant voltage charge 2.275 Volts / Cell For Stand-by, 2.450 Volts / Cell For Cycle use, when the initial charging current is controlled at 0.1CA.

Figure 8 shows one example of a constant voltage charging circuit. In this circuit, the initial charging current is limited by the series resistance R1.

Figure8. CHARGE CIRCUIT OF CONSTANT-VOLTAGE, MAX. -CURRENT LIMITED;

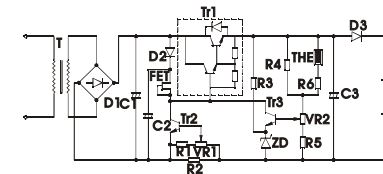

CHARGE CHARACTERISTIC OF CONSTANT-VOLTAGE, MAX. -CURRENT LIMITED

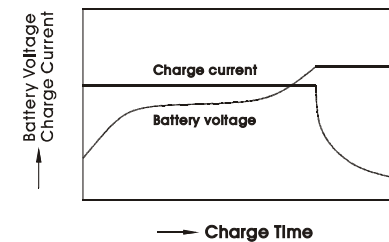

Figure8

Figure9. BATTERY CHARGING CHARACTERISTICS
(Typical example of the charge characteristics for the standby use)

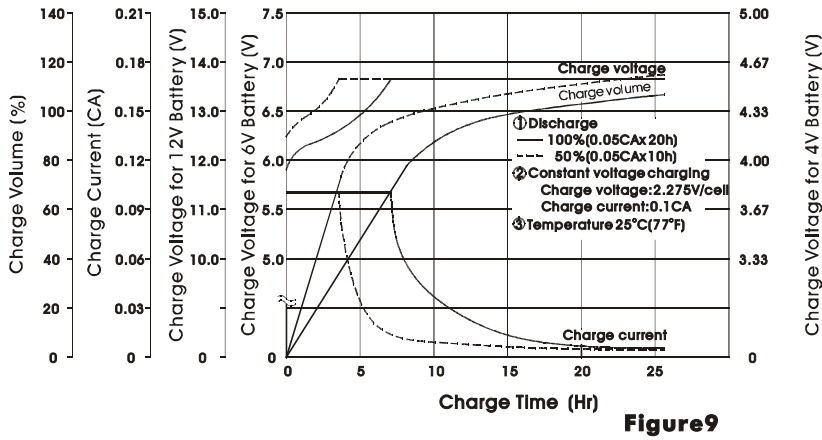

Figure9

Figure10. BATTERY CHARGING CHARACTERISTICS
(Typical example of the charge characteristics for the cycle use)

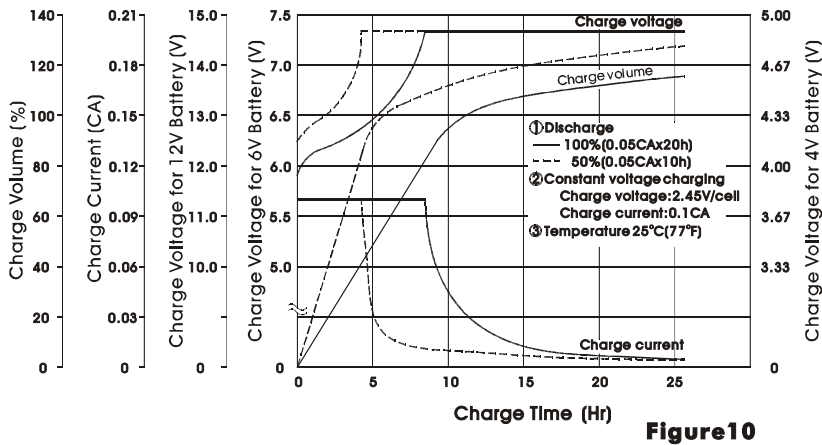

Figure10

CONSTANT CURRENT CHARGING

This charging method is not often utilized for valve regulated lead acid batteries, but is an effective method for charging a number of series connected batteries at the same time, and/or as an equalizing charge to correct variances in capacity between batteries in a series group.

Extreme care is required when charging BP batteries with a constant current. If, after the battery has reached a fully charged state, the charge is continued at the same rate, for an extended period of time, severe overcharge may occur, resulting in damage to the battery. Figure 11 shows a typical constant current charging circuit; Figure 12 shows the characteristics of a BP 7-12 battery under continuous overcharge conditions.

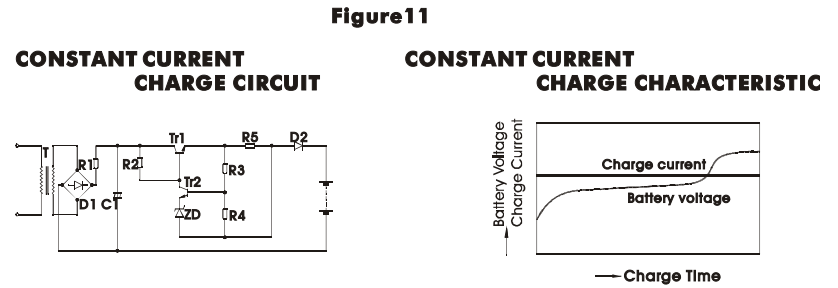

Figure11

Figure12. CONTINUOUS OVERCHARGE CHARACTERISTICS

Model : BP7-12
Overcharging current : 0.7A(0.1 CA)
Capacity test : 3Hr Rate Discharge Every 100Hours(1.75A to 10.2V)
Ambient Temperature : 25°C/77°F

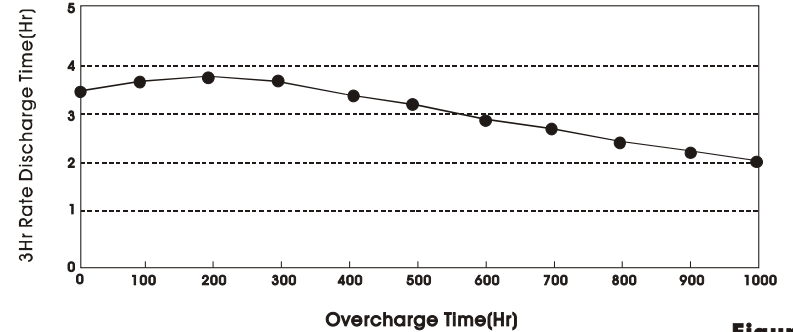
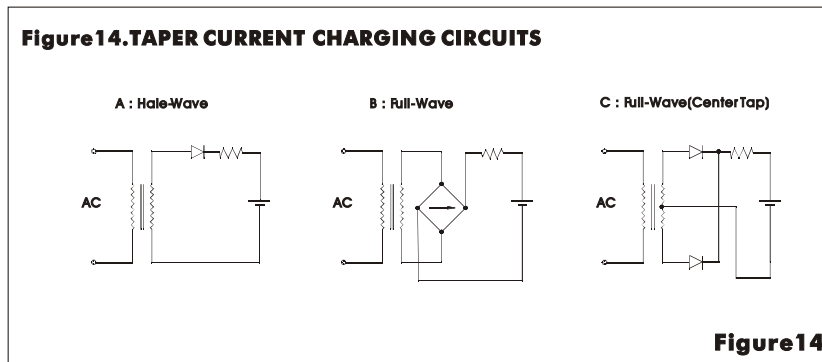
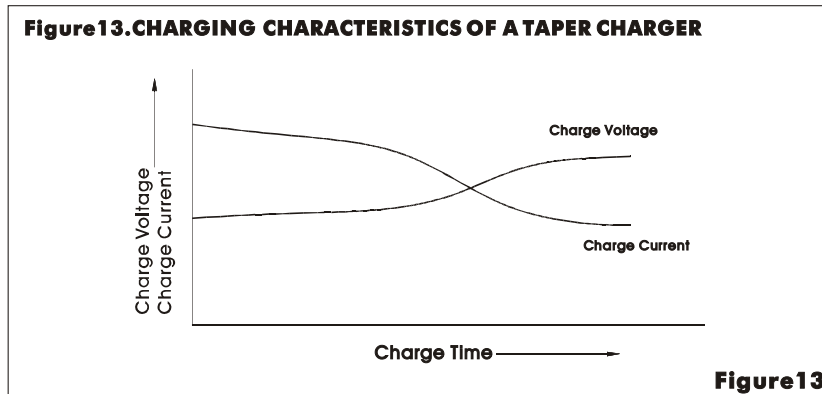

Figure12

TAPER CURRENT CHARGING

This method of charging is not recommended due to the constant current characteristics of taper charging being somewhat harsh on valve regulated lead acid batteries. This particular charging regime can often shorten battery service life. However, because of the simplicity of the circuit and subsequent low cost, taper current charging is often used to charge a number of series connected batteries that are subject to cyclic use. When using a taper charger it is recommended that the charging time is either limited or that a charging cut-off circuit be incorporated to prevent overcharge. Please consult us for specific recommendations.

In a taper current charging circuit, the charging current decreases gradually and the charging voltage rises proportionately as the charge progresses. When designing a taper charger it should be born in mind that variations in the mains input supply will be reflected in the output of the charger. Figure 13,14 illustrates the characteristics of a typical taper charger.



TWO STAGE CONSTANT VOLTAGE CHARGING

Two stage constant voltage charging is a recommended method for charging valve regulated lead acid batteries in a short period of time and then maintaining them in a fully charged float or standby condition. Figure 15 illustrates the characteristics of a two stage constant voltage charger.

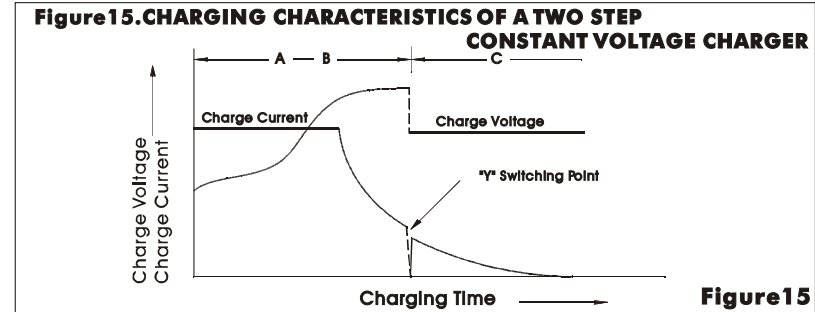

The characteristics shown in Fig.15 are those of a constant voltage, current limited charger. At the initial charging stage, the current flowing into the battery is limited to a value of 0.3C Amps. The charging voltage across the battery terminals rises, during the charging process, to a value equal to the constant voltage output of the charger, which is set to 2.45 volts per cell. Whilst continuing to charge, in stage 1 (A-B), at 2.45 volts per cell, the current will eventually decrease to point "Y", where the value of this decreasing current is "sensed" causing the circuit to switch into the second stage (B-C), reducing the charging voltage from 2.45 volts per cell to a constant voltage, float / standby, level of 2.3 volts per cell. The switch to stage two, where the constant voltage level of 2.3 volts per cell is applied, occurs after the battery has recovered about 80% of its rated capacity. This is one of the most efficient charging methods available as the recharge time is minimized during the initial stage whilst the battery is protected from overcharge by the system switching to stage 2 (float / standby) charge at the switching point "Y".

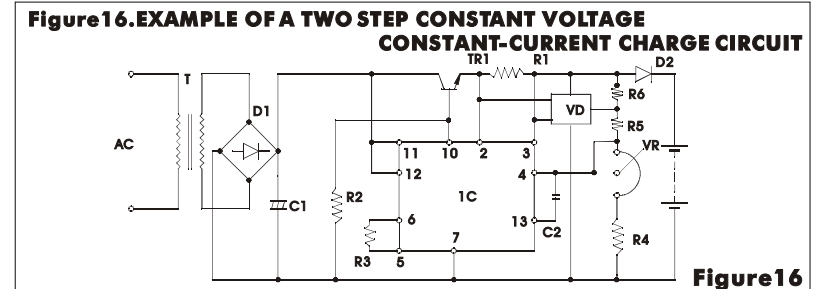

When this charging method is used, the output values will be as follows:

Initial Charge Current 0.3C Amps (max.)
 Charge Voltage:
 1st Stage 2.45V / cell (2.40 to 2.50 V / cell, max.)
 2nd Stage 2.28V / cell (2.25 to 2.30 V / cell, max.)

Switching Current From
 1st Stage to 2nd Stage 0.05C Amps
 (0.04C to 0.08C Amps)

Note: This charging method cannot be used in applications where the load and the battery are connected in parallel.

CHARGING VOLTAGE

The charging voltage should be chosen according to the type of service in which the battery will be used. Generally, the following voltages are used:

For float (standby) use2.25 to 2.30 volts per cell
 For cyclic use2.40 to 2.50 volts per cell

In a constant voltage charging system, a large amount of current will flow during the initial stage of charging but will decrease as the charging progresses. When charging at 2.30 volts per cell, the current at the final stage of charging will drop typically to a value of between 0.0005C Amps and 0.004C Amps. The charged volume in ampere hours, shown on the vertical axis of Figures 9-10, indicate the ratio of charged ampere hours to the previously discharged ampere hours. When a battery has been charged up to the level of 100% of the discharged ampere hours, the electrical energy stored and available for discharge will be 90% or more, of the energy applied during charging. Charging voltage should be regulated in relation to the ambient temperature. When the temperature is higher, the charging voltage should be lower and conversely when the temperature is lower, the charging voltage should be higher. For specific recommendations, please refer to the section on Temperature Compensation on page 26. Similarly, charged volume (measured in ampere hours) realised over a given time will vary in direct relation to the ambient temperature; the higher the ambient temperature, the higher the charged volume in a given period of time and the lower the ambient temperature, the lower the charged volume in the same given period of time. Figure 23 shows the relationship between charged volume and temperature.

Figure17.CHARGING CHARACTERISTICS AT DIFFERENT TEMPERATURES

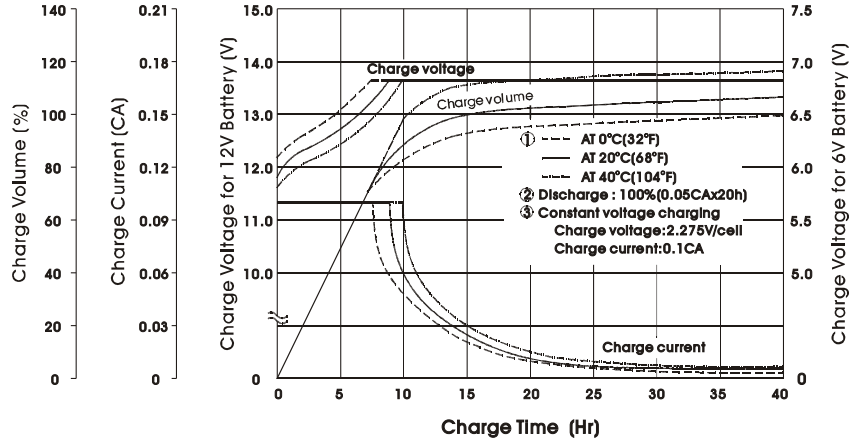

Figure17

INITIAL CHARGE CURRENT LIMIT

A discharged battery will accept a high charging current at the initial stage of charging. High charging current can cause abnormal internal heating which may damage the battery. Therefore, when applying a suitable voltage to recharge a battery that is being used in a recycling application it is necessary to limit the charging current to a value of 0.3C Amps. However, in float/standby use, BB BP batteries are designed so that even if the available charging current is higher than the recommended limit, they will not accept more than 2C Amps and the charging current will fall to a relatively small value in a very brief period of time. Normally, therefore, in the majority of float/standby applications no current limit is required. Figure 18 shows current acceptance in BP batteries charged at a constant voltage of 2.30 vpc without current limit.

When designing a charger, it is recommended that suitable circuitry is employed to prevent damage to the charger caused by short circuiting the charger output or connecting it in reverse polarity to the battery. The use of current limiting and heat sensing circuits fitted within the charger are normally sufficient for the purpose.

Figure18 .Constant Voltage Charge Characteristics With no Current Limit

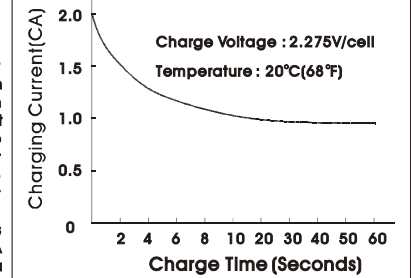

Figure18

CHARGE OUTPUT REGULATION AND ACCURACY

To ensure the correct voltage is set accurately, when adjusting the output voltage of a constant voltage charger, all adjustments must be made with the charger "ON LOAD". Adjusting the output voltage with the charger in an "OFF LOAD" condition may result in undercharging. The constant voltage range required by a battery is always defined as the voltage range applied to a battery which is fully charged. Therefore, a charger having the output characteristics illustrated in Figure 19, should be adjusted with the output voltage based on point A. The most important factor in adjusting charger output voltage is the accuracy at point A, which should be in the range of 2.25 to 2.30 volts per cell; however this accuracy is not normally required over the entire range of the load. A charger adjusted in accordance with Figure 19 will never damage a battery, even if the charger has the characteristics shown by the broken line in Figure 19.

Figure19.Output Voltage Adjustment

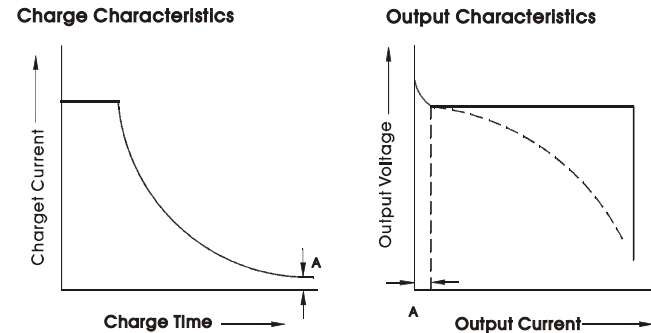

Figure19

TOP CHARGING

Since any battery loses capacity through self discharge, it is recommended that, prior to putting the battery into service, a process called "top charging" be applied to any battery which has been stored for a long period of time. Excluding conditions in which storage temperatures have been abnormally high, top charging is recommended within the following parameters:

Battery Age	Top Charging Recommendations
Within 6 months after manufacture	4 to 6 hours at constant current of 0.1C Amps or 15 to 20 hours at constant voltage of 2.45 vpc
Within 12 months after manufacture	8-10 hours at constant current of 0.1C Amps or 20 to 24 hours at constant voltage of 2.45 vpc

In order to successfully top charge a battery stored for more than 12 months, the open circuit voltage must be checked to ensure that it is higher than 2.0 volts per cell.

Therefore ALWAYS check the open circuit voltage FIRST. If the open circuit voltage of the battery is 2.0 vpc or lower, please refer to us prior to attempting to "Top Charge".

RECOVERY CHARGE AFTER DEEP DISCHARGE

When a battery has been subjected to deep discharge (commonly referred to as over discharge), the amount of electrical energy which has been discharged can be 1.5 to 2.0 times greater than the rated capacity of the battery. Consequently, a battery which has been over-discharged requires a longer charging period than normal. Please be note from Figure 20 that as a result of increased internal resistance, the charging current accepted by an over-discharged BP battery during the initial stage of charging will be quite small, but will increase rapidly over approximately the first 30 minutes until the internal resistance has been overcome, then normal, full recovery charging characteristics resume.

Figure20.CHARGING CHARACTERISTICS AFTER DEEP DISCHARGE

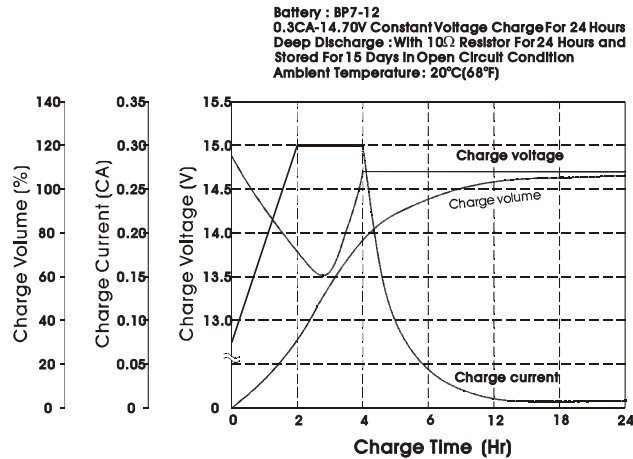

Figure20

Because of this initial small charge current, in an over discharged battery, as described above, unless due consideration is given to this fact then if the charging regime uses current monitoring for determining either the state of charge / or for signaling that the switching point has been reached for reducing the voltage to a float / standby value (as is the normal case in a multi-stage charger), the charger could be "tricked" into entering further stages before completing earlier ones. In other words the charger may give a false "full charge" indication, or may initiate charge at the float voltage figure, instead of at a higher voltage level.

TEMPERATURE COMPENSATION

As temperature rises, electrochemical activity in a battery increases and conversely decreases as temperature falls. Therefore, as the temperature rises, the charging voltage should be reduced to prevent overcharge and increased, as the temperature falls, to avoid undercharge. In general, in order to attain optimum service life, the use of a temperature compensated charger is recommended. The recommended compensation factor for BP batteries is $-3\text{mV}/^\circ\text{C}/\text{Cell}$ (for float / standby) and $-4\text{mV}/^\circ\text{C}/\text{Cell}$ (cyclic use). The standard center point for temperature compensation is $20^\circ\text{C}(0-40^\circ\text{C})$. Figure 21 shows the relationship between temperatures and charging voltages in both cyclic and float / standby applications.

Figure21.Relationship Between Charging Voltage and Temperature

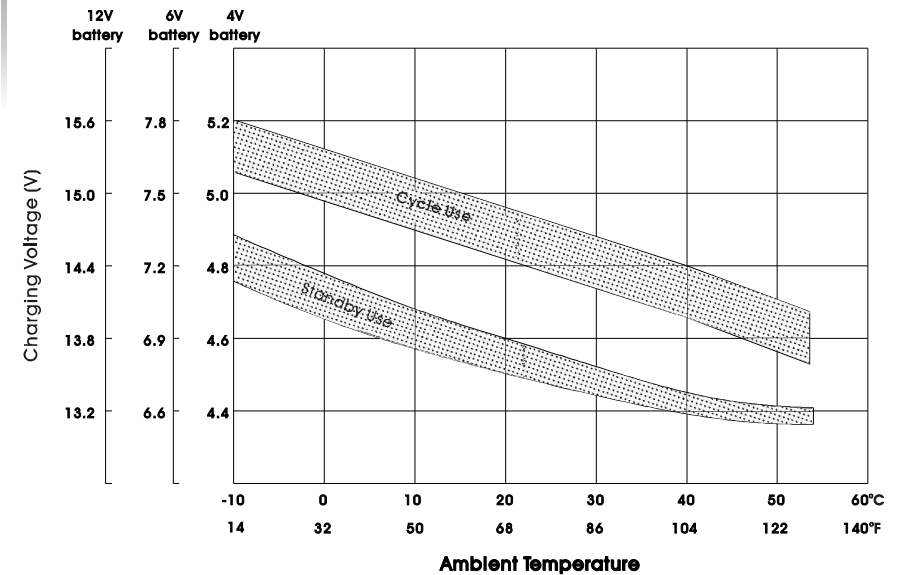

Figure21

In practice where there are short term temperature fluctuations between 5°C and 40°C , temperature compensation is not absolutely essential. However, it is desirable to set the voltage at a value shown in Figure 21 which, as closely as possible, corresponds to the average ambient temperature of the battery during its service life. When designing a charger equipped with temperature compensation, the temperature sensor must sense only the temperature of the battery. Therefore, consideration should be given to thermally isolating the battery and temperature sensor from other heat generating components in the system.

CHARGING EFFICIENCY

The charging efficiency (η) of a battery is expressed by the following formula:

$$\eta = \frac{(\text{Ah}) \text{ Ampere hours Discharged}}{(\text{Ah}) \text{ Ampere hours Charged}}$$

The charging efficiency varies depending upon the state of charge of the battery, temperatures and charging rates. Figure 22 illustrates the concept of the state of charge and charging efficiency. As shown in Figure 23, BB BP batteries exhibit very high charging efficiency, even at low charging rates, unlike some nickel cadmium batteries.

Figure22. CHARGING EFFICIENCY VS STATE OF CHARGE

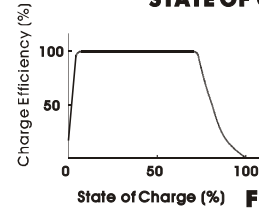

Figure23. CHARGING EFFICIENCY

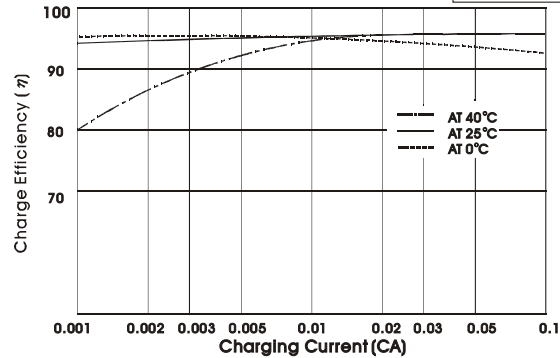

Figure23

In normal float service, where the charging voltage is maintained at 2.25 to 2.30 volts per cell (see Fig. 24), the gases generated inside an BP battery are continually recombined into the negative plates and return to the water content of the electrolyte. Therefore, electrical capacity is effectively not lost due to the "drying up" of the electrolyte; the loss of capacity and eventual end of service life is brought about by the gradual corrosion of the electrodes. It should be noted that this corrosive process will be accelerated by high ambient operating temperatures and / or high charging voltage. When designing a float service system, always consider the following: LENGTH OF SERVICE LIFE WILL BE DIRECTLY AFFECTED BY THE NUMBER OF DISCHARGE CYCLES, DEPTH OF DISCHARGE, AMBIENT TEMPERATURE AND CHARGING VOLTAGE.

Figure24. Relationship Between Float Charge Voltage and Battery Life

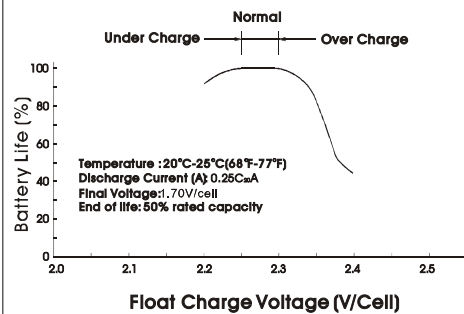

Figure24

Figure25. BP BATTERY OPEN CIRCUIT VOLTAGE VS REMAINING CAPACITY

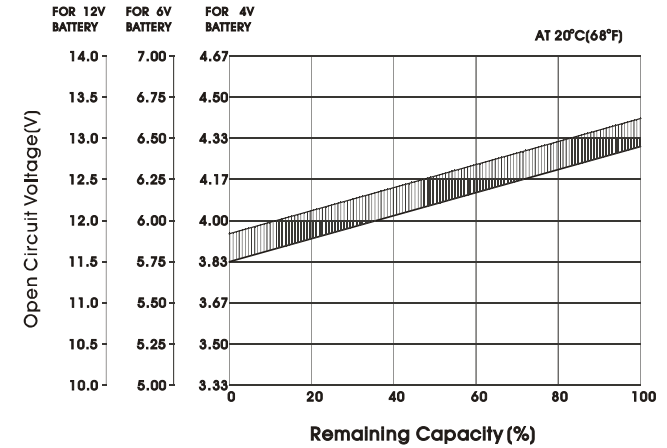

Figure25

DESIGN / APPLICATION TIPS TO ENSURE MAXIMUM SERVICE

BB BP batteries are highly efficient maintenance free electrochemical systems designed to provide years of trouble free electrical energy. The performance and service life of these batteries can be maximized by observing the following guidelines:

- Heat kills batteries. Avoid placing batteries in close proximity to heat sources of any kind. The longest service life will be obtained where the battery temperature does not exceed 20°C. (also see notes 3 & 8 hereunder). When calculating the correct float voltage setting, whether or not temperature compensation is required, full consideration must be given to the temperature of the battery and room ambient. For the purpose of the calculation, consider the temperature of a battery on float to be 1°C above local ambient. Also, if the battery is used in an enclosure, the temperature gradient of the enclosure itself must be included in the calculation. I.e. The operating temperature of the battery is given by: -Room temperature + enclosure temperature + 1°C.
- Since a battery may generate ignitable gases, do not install close to any equipment that can produce electrical discharges in the form of sparks.
- When the battery is operated in a confined space, adequate ventilation should be provided.
- The battery case is manufactured from high impact ABS plastic resin. It should not be placed in an atmosphere of or in contact with organic solvents or adhesive materials.
- Correct terminals should be used on battery connecting wires. Soldering is not recommended but if unavoidable please refer to us for further guidance.
- Avoid operating at temperatures outside the range -15 to +50°C. for float / standby applications and +5 to +35°C. for cyclic use.
- When there is a possibility of the battery being subjected to heavy vibration or mechanical shock, it should be fastened securely and the use of shock absorbent material is advisable.
- When connecting the batteries, free air space must be provided between each battery. The recommended minimum space between batteries is 10mm. In all installations due consideration must be given to adequate ventilation for the purposes of cooling.
- When the batteries are to be assembled in series to provide more than 100V, proper handling and safety procedures must be observed to prevent accidental electric shock. (See note #16 below).
- If 2 or more battery groups are to be used, connected in parallel, they must be connected to the load through lengths of wires, cables or busbars that have the same loop line resistance as each other. This makes sure that each parallel bank of batteries presents the same impedance to the load as any other of the parallel banks thereby ensuring correct equalization of the source to allow for maximum energy transfer to the load.
- To obtain maximum life, the ripple current flowing in the battery, from any source, should not exceed 0.1C Amps R.M.S.
- When cleaning the battery case, ALWAYS use a water soaked wet or dampened cloth but NEVER use oils, organic solvents such as petrol, paint thinners etc. DO NOT even use a cloth that is impregnated or has been in contact with any of these or similar substances.
- Avoid touching with oil, organic solvent and adhesive materials or chemical objects with these substance composed such as: petrol, acetic acid, PVC, diluent or rubber, etc. touching with these materials may lead to container crack or even acid leakage.
- Do not attempt to dismantle the battery. If accidental skin / eye contact is made with the electrolyte, wash or bathe the affected area / part straight away with liberal amounts of clean fresh water and seek IMMEDIATE medical attention.
- DO NOT INCINERATE batteries as they are liable to rupture if placed into a fire. Batteries, that have reached the end of their service life, can be returned to us for safe disposal.
- Touching electrically conductive parts might result in an electric shock. Be sure to wear rubber gloves before inspection or maintenance work.
- The use of mixed batteries with different capacities, that may have been subjected to different uses, be of different ages and are of different manufacturers is liable to cause damage to the battery itself and / or the associated equipment. If this is unavoidable please consult us beforehand.
- To obtain maximum life, batteries should never be stored in a discharged state.
- In order to obtain maximum working life, when the batteries are used in an UPS system, the following is advised:-
 - Where the D.C. input exceeds 60 volts, each battery should be insulated from the battery stand by using suitable polypropylene or polyethylene material.
 - In high voltage systems the resistance between battery and stand should always be greater than 1 Megohm. An appropriate alarm circuit could be incorporated to monitor any current flow.

GLOSSARY

- Ampere (A)** The unit for measuring the flow of electric current.
- Ampere hour (Ah)** The current in (A amperes) multiplied by time in (h hours). Used to indicate the capacity of a battery.
- Capacity (C)** Ampere hours that can be discharged from a battery.
- Cell** The minimum unit of which a battery is composed, consisting of positive and negative plates, separators, electrolyte, etc. In valve regulated lead acid batteries, the nominal voltage is 2 volts per cell.
- Charging** The process of storing electrical energy in a battery in a chemical form.
- Cyclic Service** The use of a battery with alternate repetition of charging and discharging.
- Cycle Service Life** The total number of cycles expected at a given depth of discharge.
- Deep Discharge** (a) Discharge of a battery until 100% of the capacity is exhausted.
(b) Discharge of a battery until the voltage under load drops below the specified final discharge voltage. (Over discharge).
- Depth of Discharge** The ratio of discharge capacity vs. the rated capacity of a battery.
- Discharge** The process of drawing stored energy out of a battery in the form of electrical power.
- Energy Density** The ratio of energy that can be discharged from a battery to the volume of that battery measured in Watt Hours (WH) per cubic inch, or litre.
- Float Service** Method of use in which the battery and the load are connected in parallel to a float charger (or rectifier) so the constant voltage is applied to the battery continuously, maintaining the battery in a fully charged state and to supply power to the load from the battery without interruption or load variation.
- Gas Recombination** The process by which oxygen gas generated from the positive plates during the final stage of charging is absorbed into the negative plates, reducing the potential at the negative plates, so suppressing the generation of hydrogen.
- Impedance** The ratio of voltage variation vs. current variation in alternation (a.c.) supply.
- Internal Resistance** The term given to the resistance inside a battery, consisting of the sum of resistance of the electrolyte, the positive and negative plates & separators, etc.
- Life Expectancy** Expected service life of a battery expressed in total cycles or time in float service in relation to a specified application.
- Nominal Capacity** The nominal value of rated capacity. In valve regulated lead acid batteries nominal capacity is usually measured at the 20 hour rate, although higher rate discharge types have their nominal capacities given at the 10 hour rate.
- Nominal Voltage** The nominal value of rated voltage. In lead acid batteries, nominal voltage is 2 volts per cell.
- Open circuit Volts** The voltage of a battery which is isolated electrically from any external circuit, i.e. the voltage is measured in a no load condition.
- Parallel Connection** Connection of a group of batteries by interconnecting all terminals of the same polarity, thereby increasing the capacity of the battery group but not increasing voltage.
- Recovery Charge** The process of charging a discharged battery to restore its capacity in preparation for subsequent discharge.
- Sealed** The word "Sealed" is used as a relative term when referring to cells in BB batteries compared with open vented free electrolyte types.
- Self Discharge** Loss of capacity without external current drain.
- Series Connection** Connection of a group of batteries by sequentially interconnecting the terminals of opposite polarity thereby increasing the voltage of the battery group but not increasing capacity.
- Shallow Discharge** Discharge of a battery in which discharge is less than 50% depth of discharge. (D.O.D.)
- Shelf Life** The maximum period of time a battery can be stored, under specified conditions, without needing supplementary charging.
- Standby Service** General term for an application in which the battery is maintained in a fully charged condition by trickle or float charging. Synonymous with Float Service.
- Trickle Charge** Continuous charging by means of a small current designed to compensate for self discharge in a battery which is isolated from any load. For valve regulated lead acid batteries, constant voltage charging is common.
- Charged Volume** The power returned to the battery by charging as a percentage of the power taken out during discharge.